

# Is there a global education?



ARCHITECTS' COUNCIL OF EUROPE  
CONSEIL DES ARCHITECTES D'EUROPE

**Matteo Robiglio**  
**Integrated Strategies**



Matteo Robiglio *Is there a global education?*



Matteo Robiglio *Is there a global education?*

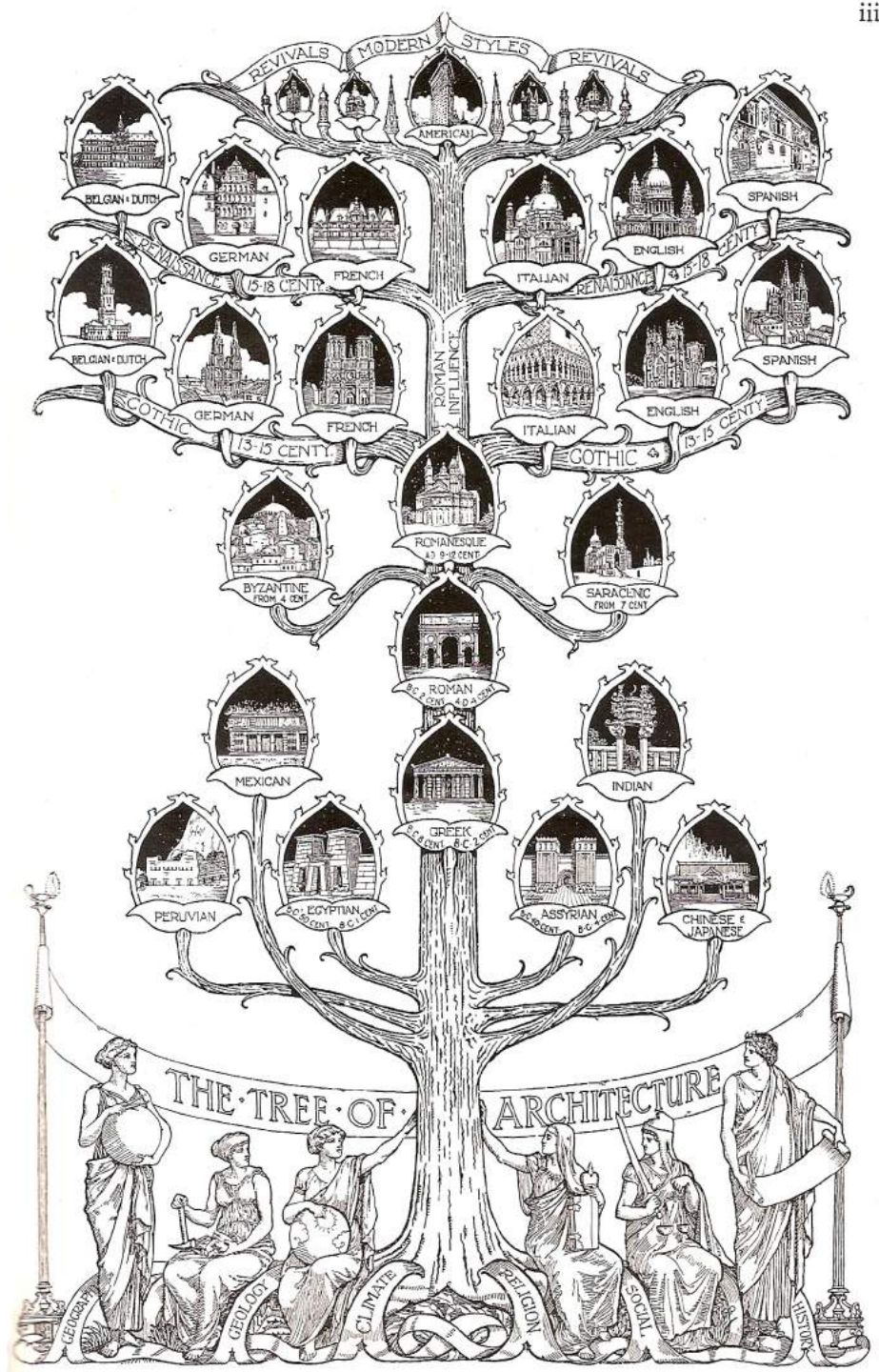

Matteo Robiglio *Is there a global education?*



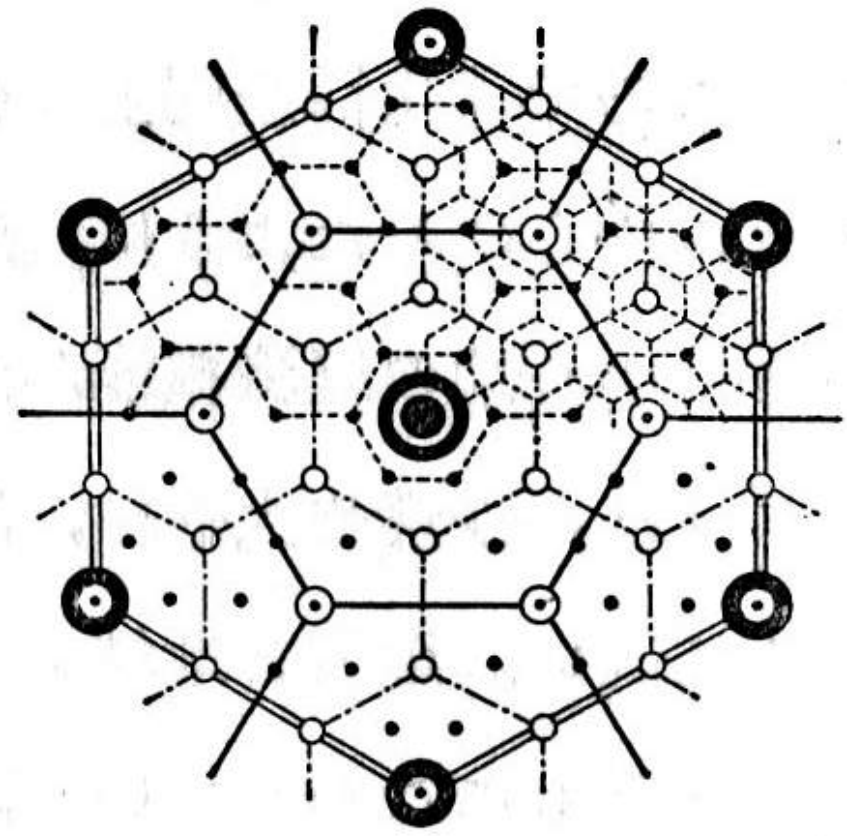
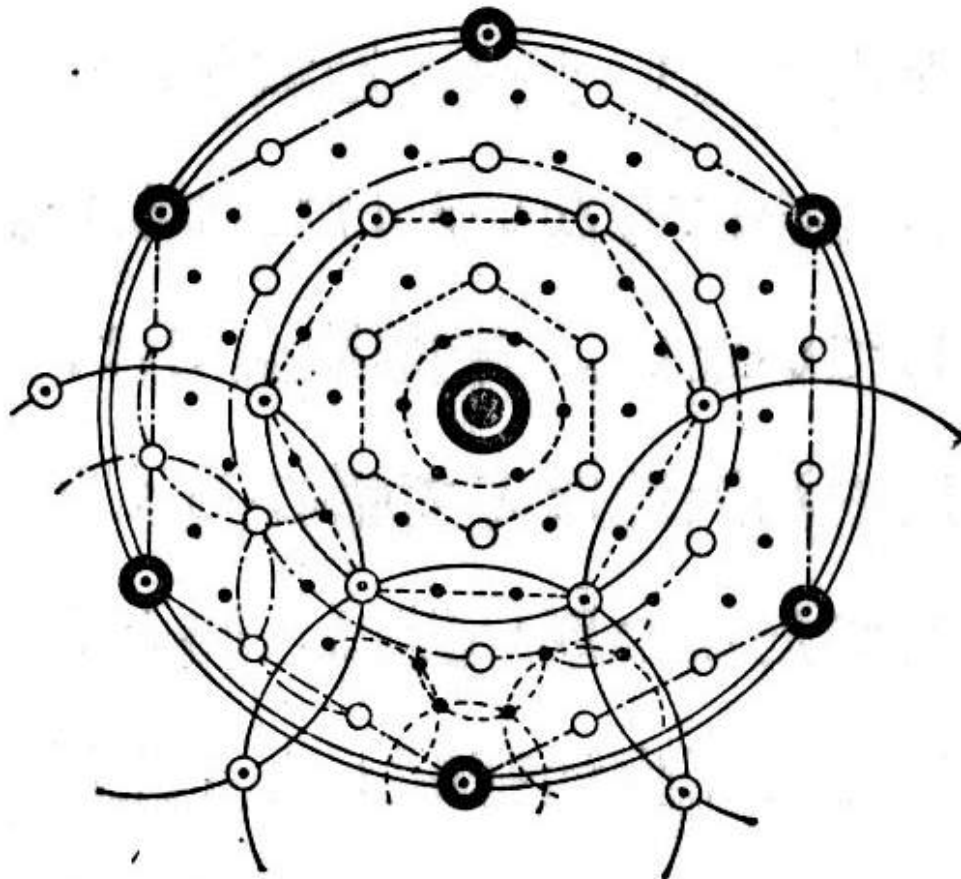

	<b>ITALIA</b>	/EU	/WORLD	<b>EU</b>	/WORLD	<b>GLOBAL</b>
ARCHITECTURE SCHOOLS	<b>34</b>	10%	3%	<b>342</b>	28%	<b>1226</b>
TOP 100	<b>3</b>	9%	3%	<b>34</b>	34%	<b>100</b>
ARCHITECTS	<b>153000</b>	27%	12%	<b>565000</b>	43%	<b>1320000</b>
POPULATION (M)	<b>60,6</b>	12%	1%	<b>503,7</b>	7%	<b>7477,2</b>
MIDDLE CLASS (M)	<b>30</b>	10%	2%	<b>300</b>	17%	<b>1800</b>
CONSTRUCTION (M€)	<b>184111</b>	11%	2%	<b>1664000</b>	18%	<b>9265000</b>

SOURCES: UIA 2015, ACE 2016, COAC 2005, PWC 2015, CREDIT SUISSE 2015, ILO 2015, OECD 2015

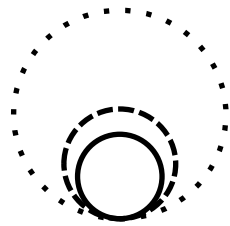

**ARCHITECTS** 153.000 12%  
**SCHOOLS** 34 3%  
**[TOP100:]** [3]  
**CONSTRUCTION** 184.100 M€ 2%

## ITALIA

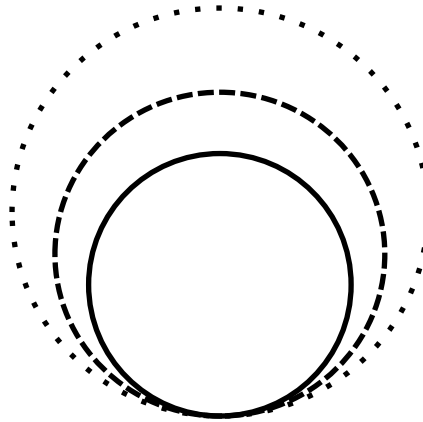

**565.000** 43%  
**342** 28%  
**[34]**  
**1.664.000 M€** 18%

## EU

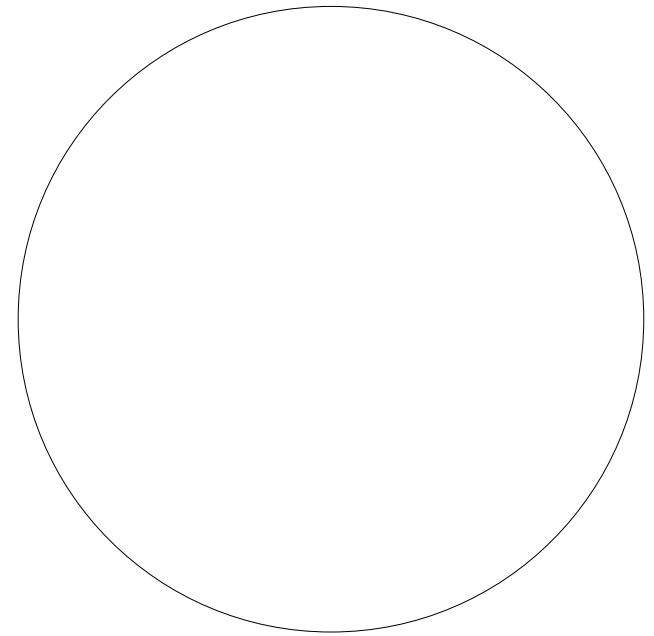

**1.320.000**  
**1.226**  
**[100]**  
**9.265.000 M€**

## GLOBAL







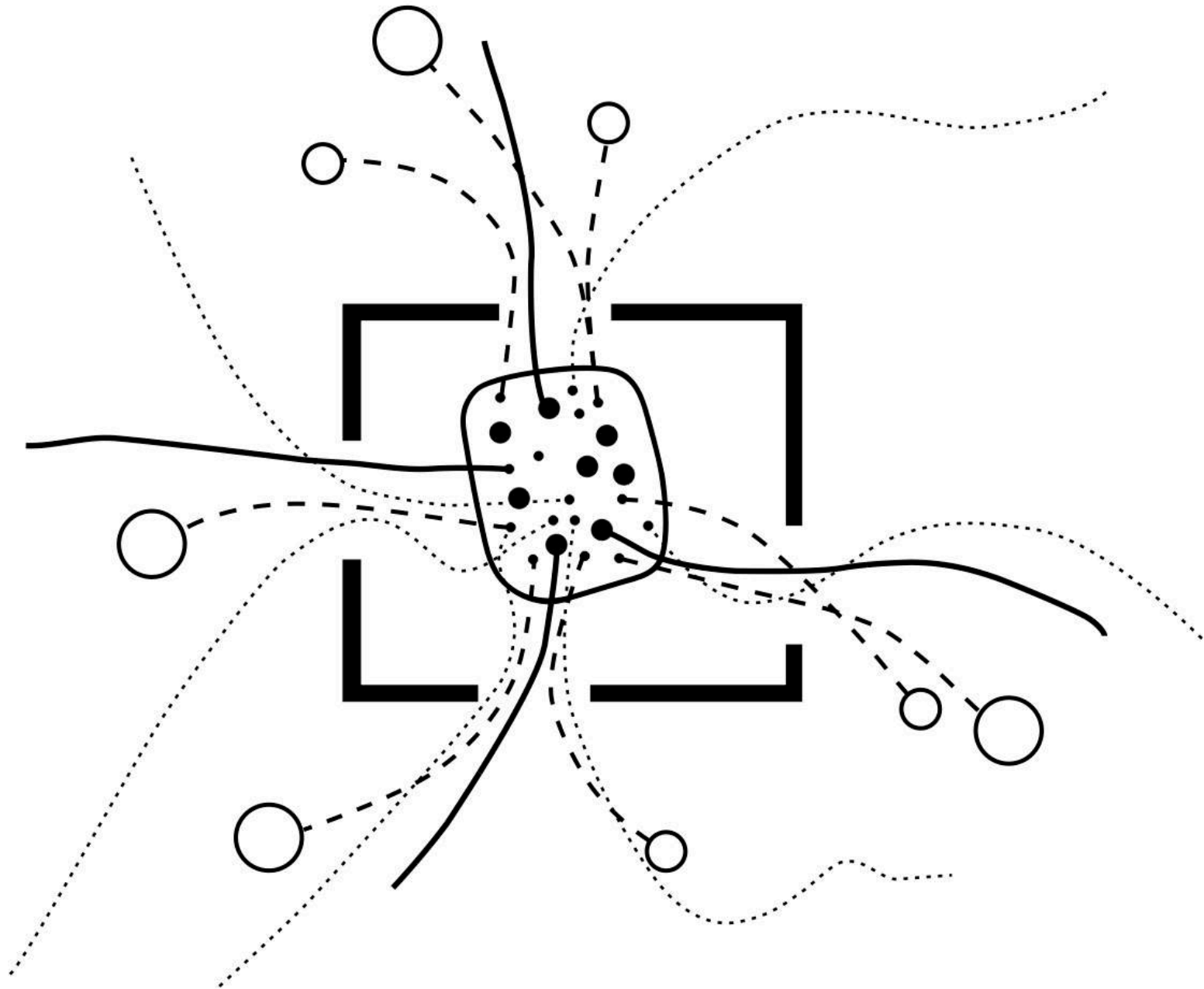

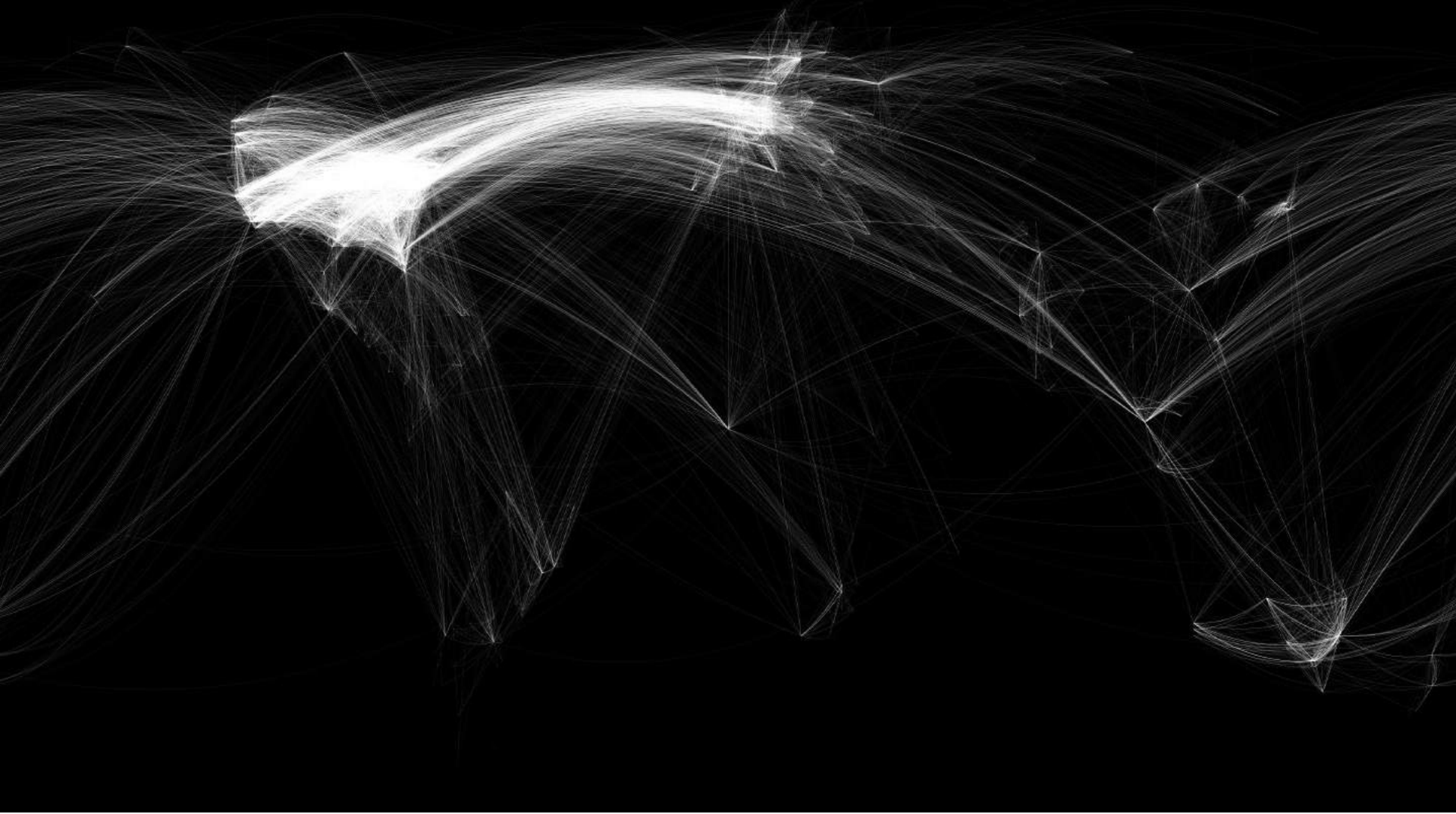

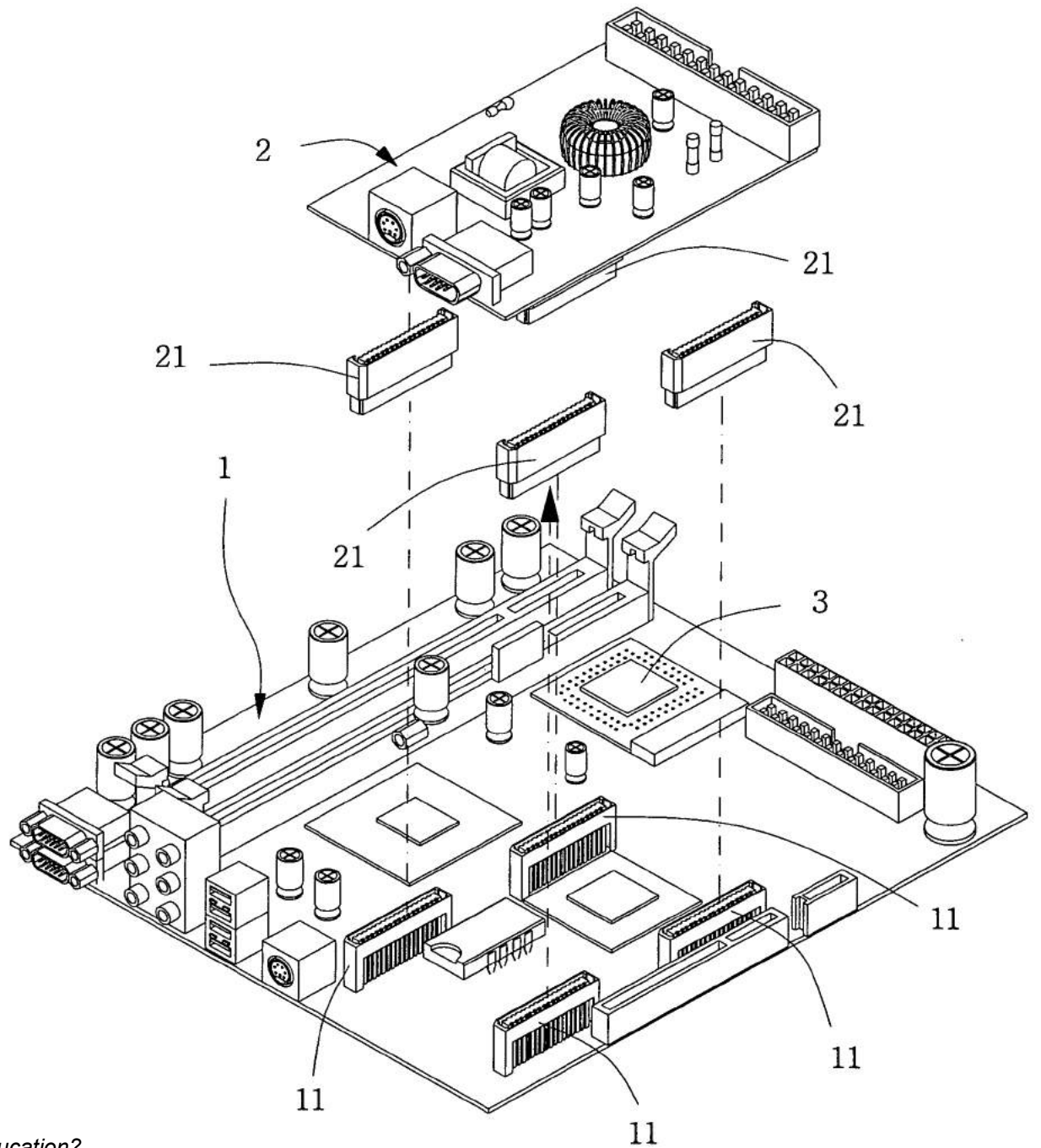

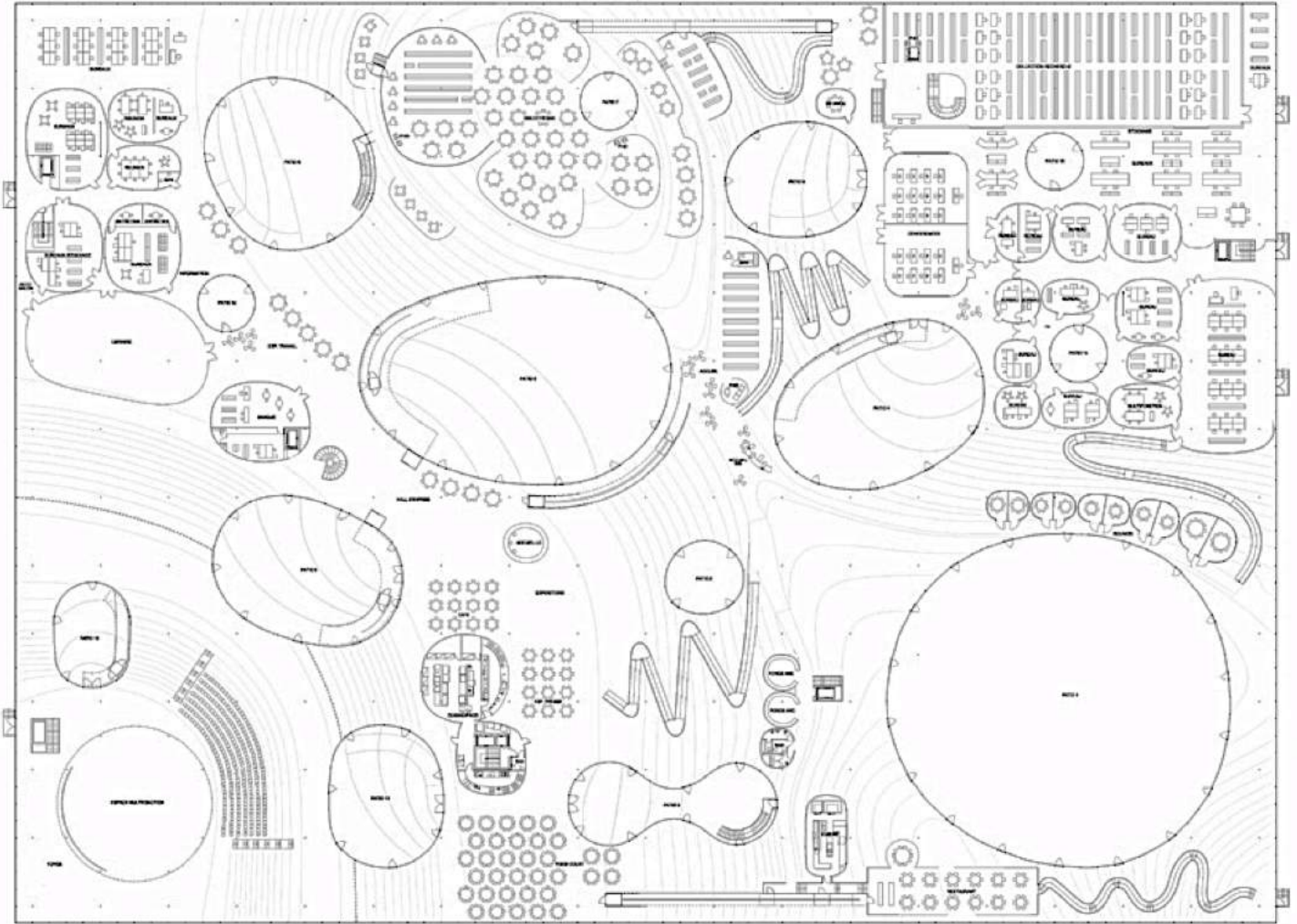



Matteo Robiglio *Is there a global education?*







# Open Night

Iaac | FAB LAB  
BARCELONA



POBLENOU  
URBAN  
DISTRICT





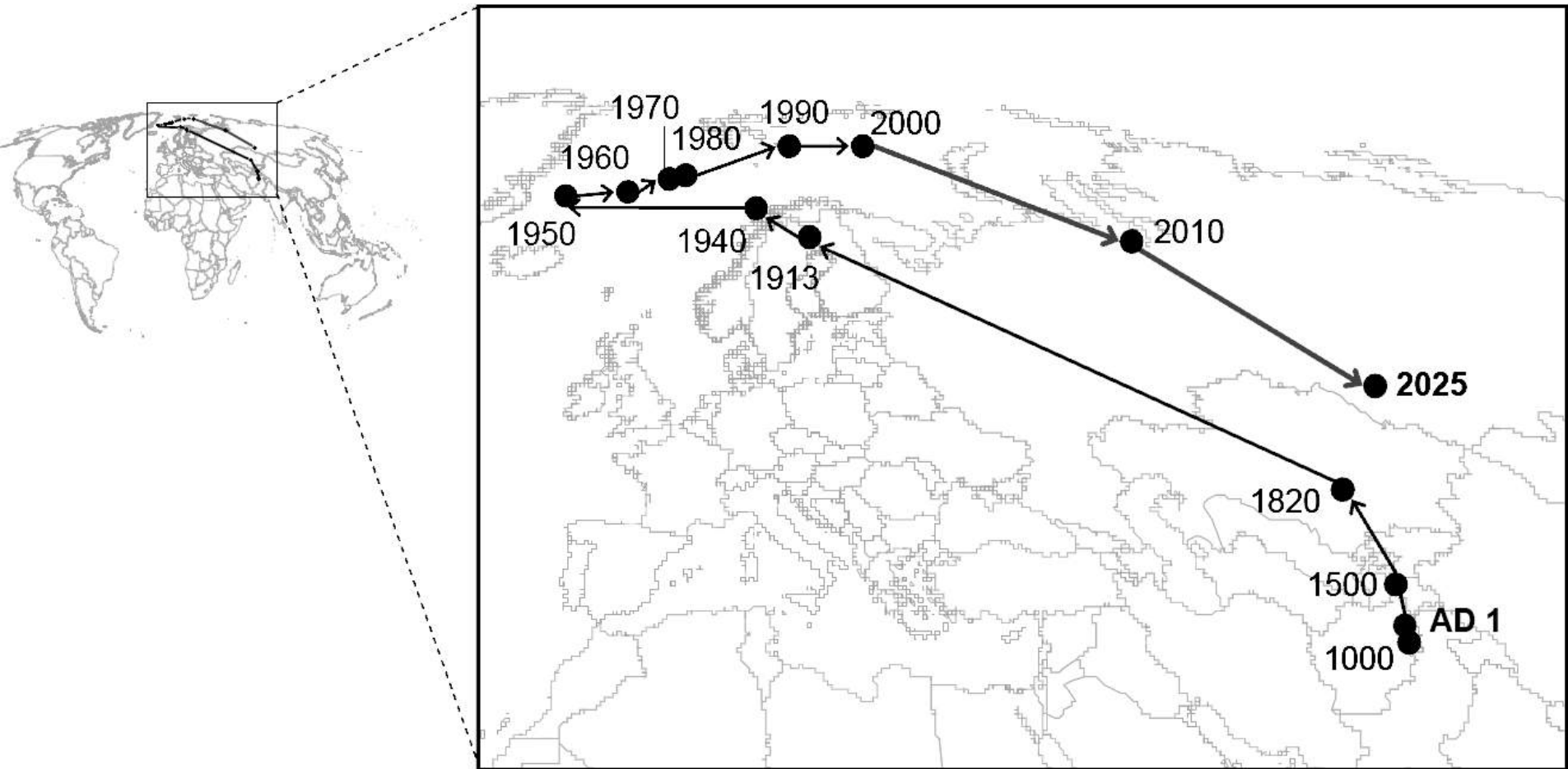



# Thank you for your attention



ARCHITECTS' COUNCIL OF EUROPE  
CONSEIL DES ARCHITECTES D'EUROPE

[www.ace-cae.eu](http://www.ace-cae.eu)

